

I þuk dk vf/kdkj vf/kfu; e
2005 dh /kkjk 4 ¼½ [k ds
vUrxr mRrjk[k.M i qyl
dk 17 fclnqka dk ešqy
dk l xg tul keU; ds
voykduKkZ gra

i qyl folkx tuin ngjknw
mRrjk[k.MA

i fýl foHkx tuin nsjknw 1mRrjk[k.M½

Hkkjr ljdkj }kjk **l puk dk vf/kdkj vf/kfu; e 2005[^] ds /kkjk&4¼¼½ch½ rFkk /kkjk&4¼½ 4&¼½ rFkk /kkjk 4&¼½ ¼¼½ eafufgr ykd ikf/kdkjh }kjk 17 fclnq/ka ij l pukvka dk LoSPNd idVuA

fclnq l ¼; k &01

i fýl foHkx dh fof" k'V; ka] dR; vj dR;

i fýl cy dh fof" k'V; ka] dR; vj dR; dk foj.k vdr fd; s tkus l s i wZ foHkxh; bfrgl dh tkudkj] l xBu dh l j puk dk foj.k fn; k tkuk vko" ; d irhr gkrk gS tks fuEuor gA

foHkxh; bfrgl dh tkudkj %i fýl foHkx dk bfrgl dkQh ij kuk gS l Ekor% o s nd dky l s Hkh i wZ vey es vk; k gkxk D; kfd vFk' kkl= ds izkrk dksVY; ds) kjk Hkh fy[kk x; k gSA ftl ds i wZ tks es vrhr es Lokeh HkDr dk ifjp; fn; k gk l q' khy]f" kf{kr} vujDr i R; d dk; Z dks HkyHkkrh l kp l e > dj djus okys 0; fDr dks gh jtkk }kjk vax j {kd ds in ij fu; Dr djuk pfg, A vr% bl ys[k l sirk pyrk gS fd i fýl dk bfrgl dkQh ij kuk gSA ml l e; 5&6 fl ikfg; ks dk dek.Mj i Rikr] 30 fl ikfg; ks dk i Hkjh xkSYed] 100 fl ikfg; ka dk i Hkjh "krkuhd] 1000 fl ikfg; ka dk i Hkjh l gfl d vj 10000 fl ikfg; ka dk i Hkjh vk; frd dgykrk Fk A tksfd vkt l e; vj l ekt ds cnyko o ik" pkr; l dfr ds i Hkko ds dkj.k uke cnydj de" k% gM dkul Vfcy] l c bul i DVj] bul i DVj] i fýl v/kh{kd rFkk mi egkfujh{kd gkx; s gA

i fýl foHkx ds dk; Z Hkh ikphu dky l s gh fu; r gS D; kfd ikphu dky ea fy[ks x; s xDFk ** kd ufr[^] ds i Fke v/; k; ea ; g mYs[k feyrk gS fd i fýl dks jkf= ea x" r djrs l e; xk l s fudyus okys o i s" k djus okyka dh l ko/kkuh i wZ ryk" kh ysuh pfg, A bl idkj ge ns[krs gS fd i fýl foHkx dkQh ij kuk foHkx gSA ; g dguk vufpr u gkxk fd ekuork ds fodkl ds l kFk gh i fýl dk bfrgl Hkh jgk gA

l e; kupæ ds fgl kc l s Hkkjr ea NkV&NkV/s jkT; gpk djrs Fks rFkk l Hkh jtkvka dh viuh i fýl o QkSt s Fkh ftudh os" k Hkwkk Hkh fHkUu fHkUu idkj dh Fkh Al e; cnyrk x; k vj Hkkjr ns" k vaxt ka ds v/khu gkx; kA l kjs Hkkjr ij vaxth "kkl u gkus ds QyLo: i ijs ns" k ds i fýl cy ea , d : irk ykus ds fy, rRdkyhu Hkkjr ljdkj us 6 l nL; ka dk , d deh" ku **feLVj , e , p dks/ Z[^] dh v/; {krk ea 1860 ea xFBr fd; k x; k tksfd i Fke vky bM; k i fýl deh" ku dh fjik/ Z ij mRrj ins" k i fýl xBu o' kZ 1861 ea **North Western Provision Police" ds uke l s gvkA bl ds ckn l u 1876 ea bl dk uke cnydj **North Western Provision Police" j [kk x; kA o' kZ 1902 ea bl dk uke **United Provision Police" j [kk x; kA

LorU=rk ikflr ds ckn i kUrks dk xBu gkus ds ckn l u 1956 ea bl dk uke mRrj ins" k i fýl j [kk x; kA

feLVj ,e ,l dksV dh fjikVZ ds vk/kkj ij iKurh; Lrj ij buI iDVj tuju vKd ifyl dh 0; oLFkk dh x; h ftl ds v/khu ins' k dk l eLr ifyl cy j [kk x; kA ukFkZ oLVuZ ds igys buI iDVj tuju vKd ifyl ,e ,p dkVZ dks gh cuk; k x; k Fkk rFkk blgh dh l rqrh; ka ds vk/kkj ij gh Hkkjr ea ifyl 0; oLFkki uk dh x; h A tksfd orZku ea Hkh ipfyr gA blgh ds funZ' ku ea iR; d ftys dks l fdy es foHkDr fd; k x; k rFkk l fdy dk blpktZ buI iDVj dks cuk; k x; k buds v/khu dbZ Fkkus gq/k djrs FkA ftyk Lrj ij ifyl v/kh{k d dh fu; qDr gq/k djrh FkA ofj'B ifyl v/kh{k d iKur ea dny 6 uxjks ea %dkuig jvkxjk] ejB]cukj l bykgkcn vks y[kum½ gq/k djrh Fkh Ao'kZ 1982 ea buI iDVj tuju vKd ifyl ds in dks mPphdr djds Mk; jDVj tuju vKd ifyl ds in dh LFkki uk dh x; hA o'kZ 1994 ea tuin nsjknw ea ifyl v/kh{k d ds in dks mPphdr djds ofj'B ifyl v/kh{k d dh fu; qDr dh x; hA

fnukad 9-11-2000 dks mRrj ins' k l s 13 ftyka dks vvx djds mRrjk [k.M jkT; cuk; k x; k ftl ea tuin fVgjh x<oky] iKs/h x<oky] mRrjdk" kh] : niz, kx] pekyh] gfj}kj] nsjknw] fiFKS kx<] pEikor] ckxs' ojj vYekMq] ushrky o m/ke fl g uxj dks l fefyr fd; k x; k A nsjknw tuin dks mRrjk [k.M jkT; dh jkt/kkuh gkus dk xkso iKur gq/kk A

ifyl foHkkx dk l xBu ins' k Lrj ij ifyl egkfun's kd] ifj {ks= Lrj ij ifyl mi egkfujh{k d , oafyk Lrj ij ofj'B@ ifyl v/kh{k d ds usRo ea xFBr gsk gS ifyl foHkkx dk l xBuRed <kpk fuEuor g&

- 1& ifyl egkfun's kd & jkT; Lrj
- 2& ifyl mi egkfujh{k d & ifj {ks= Lrj
- 3& ofj'B@ ifyl v/kh{k d & tuin Lrj
- 4& ifyl mi k/kh{k d @ {ks= kf/kdkjh & l fdy Lrj
- 5& Fkkuk/; {k & Fkkuk Lrj

tuin Lrjh; ifyl l xBu dks eq; ; r%6 Hkkxka ea foHkkt r fd; k x; k gS

- 1& dkuw 0; oLFkk@ "kkfUr 0; oLFkk cuk; sj [kus grA
- 2& LFkkuh; Lrj ij vfhkl puk l dyu grA
- 3& fjtoZ ifyl cy¼ " kL=@; krk; kr o ifjogu l fgr½ grA
- 4& l pkj 0; oLFkk grA
- 5& dk; ky; izU/ku grA
- 6& vfxu" keu 0; oLFkk grA

orZku ea mRrjk [k.M jkT; ea ifyl foHkkx dk inokj fooj.k fuEu izdkj g&

1&dkumu&0; oLFkk @" kkrUr 0; oLFkk gr&

0kfj' B i fyi
v/kh{k d

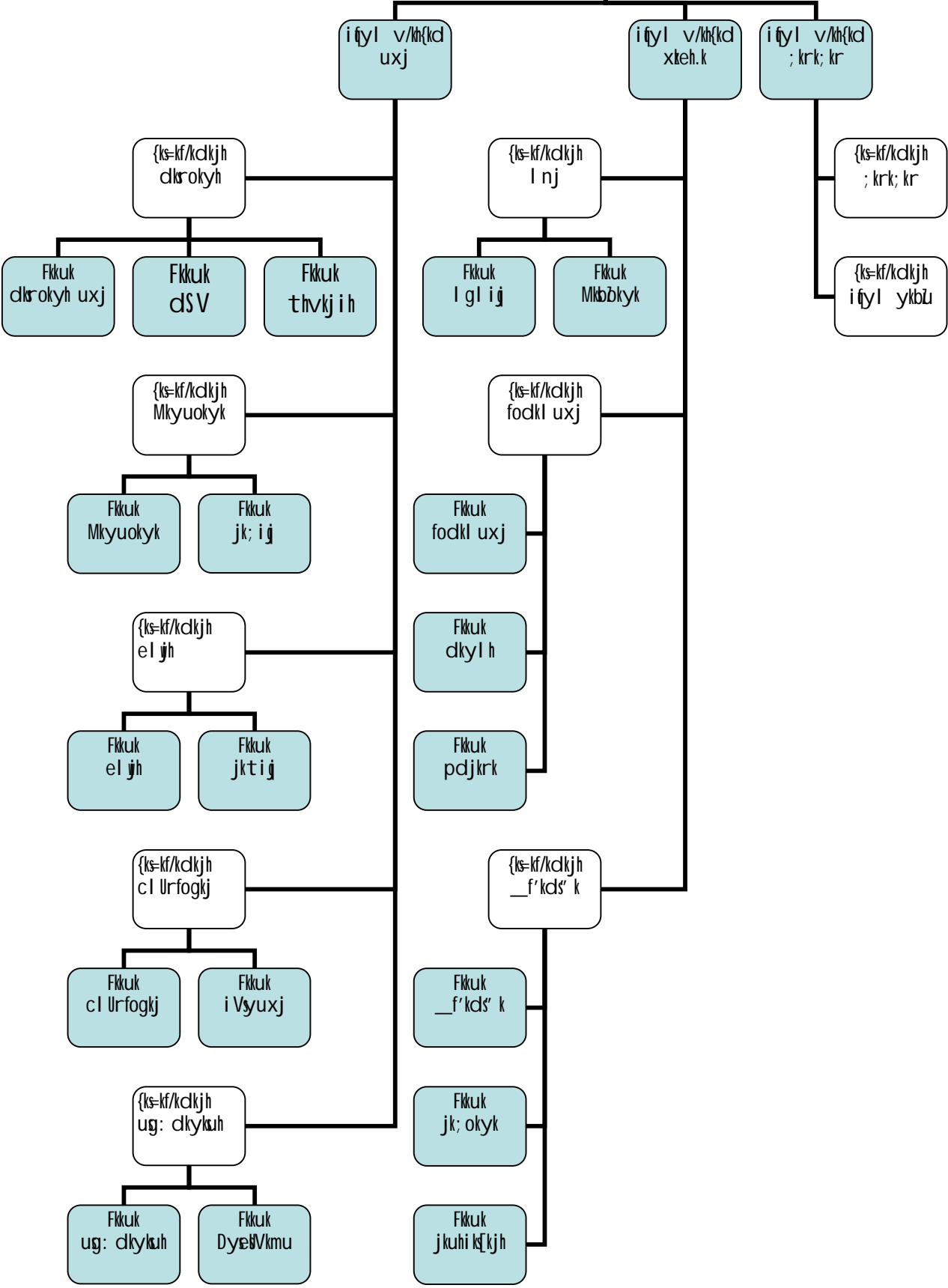

2- LFkkuh; Lrj ij vfhkl p̄uk l d̄yu gr̄q %&

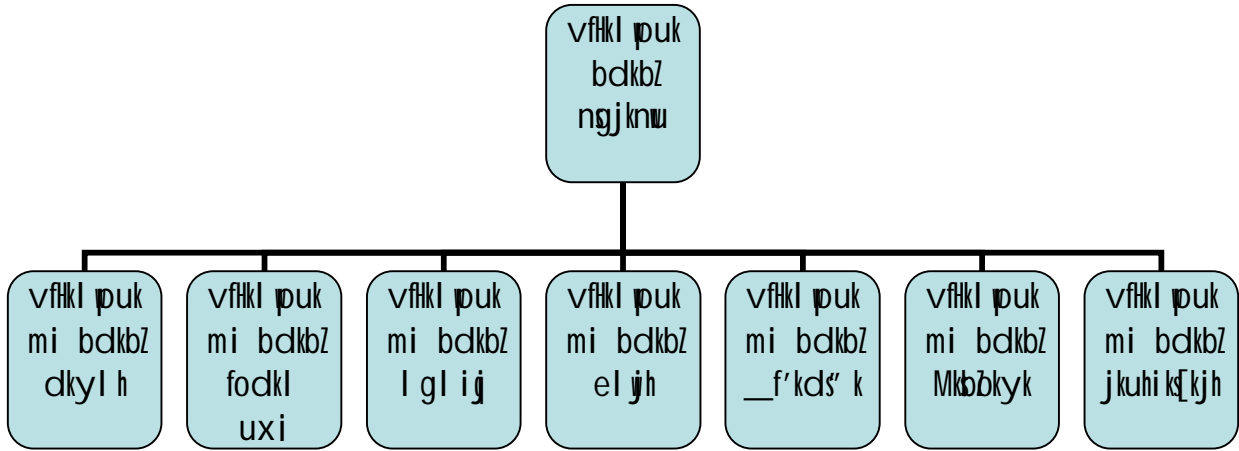

3- fjtozifyl cy %&

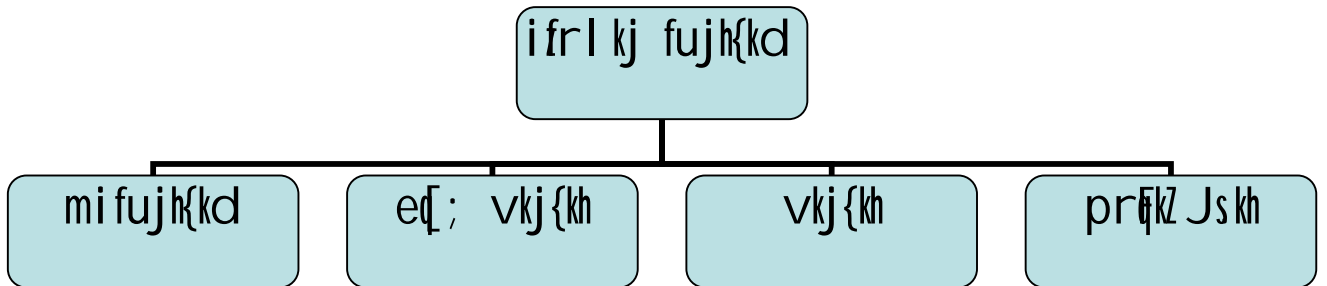

4- l p̄kj 0; oLFkk %&

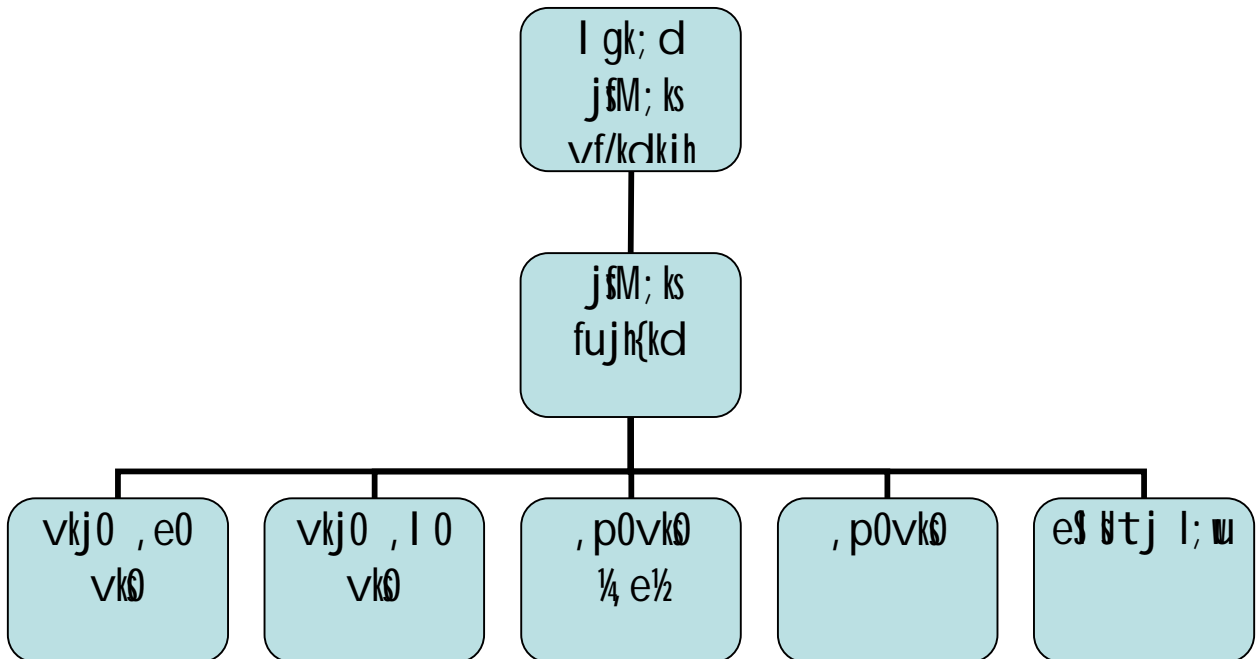

5- dk; k̄y; iɔU/k %&

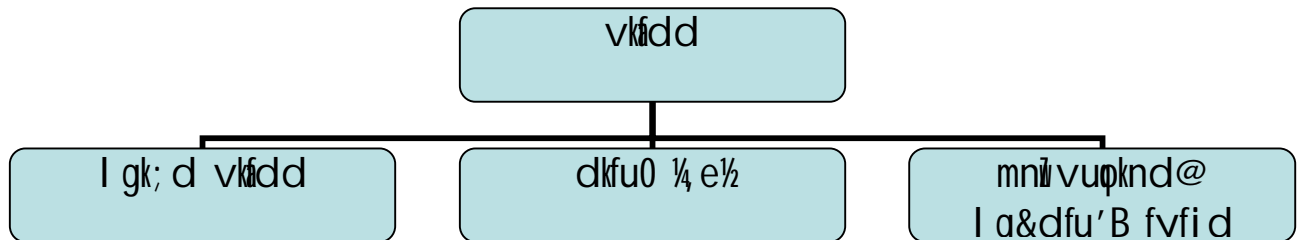
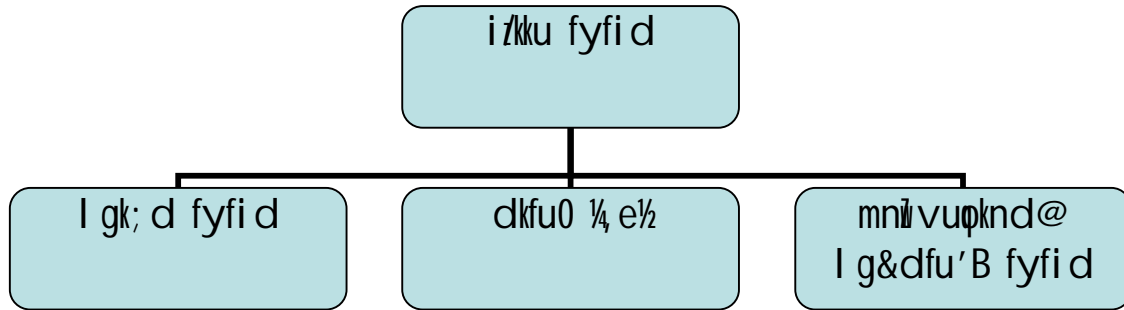

6- vfxu" keu 0; oLFkk gr̄q %&

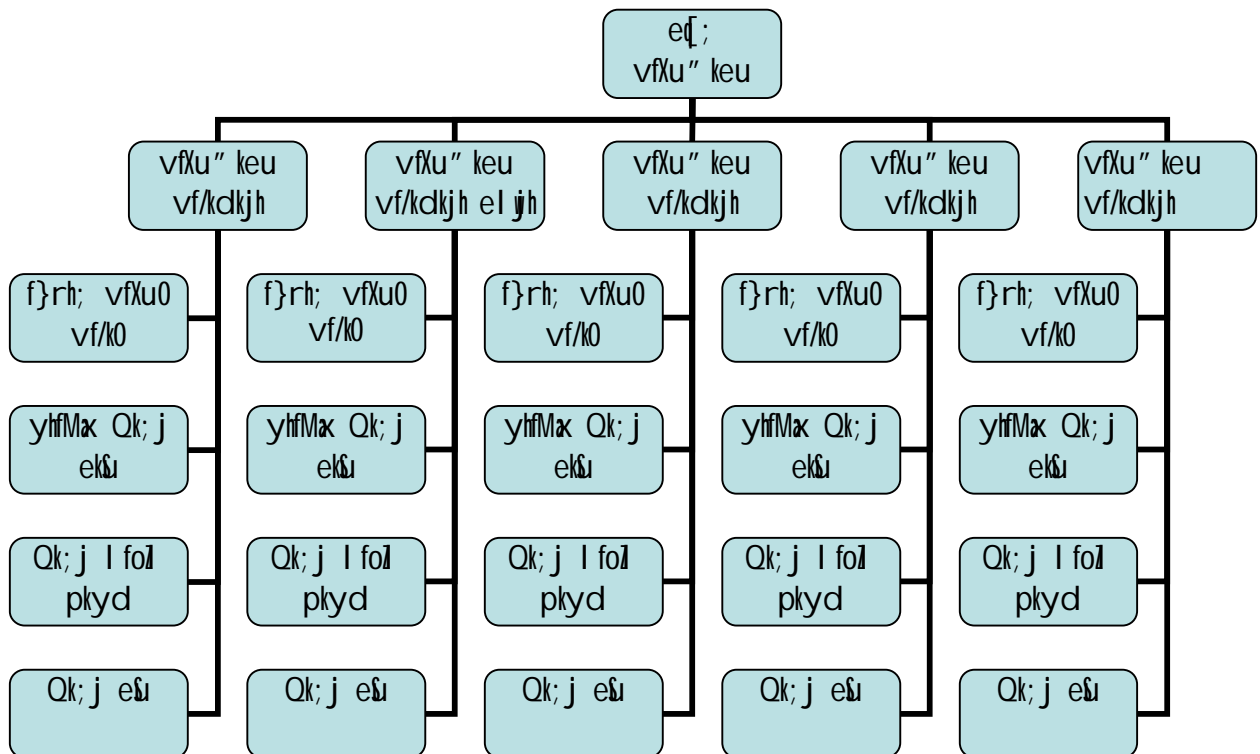

fof''kf'V; ka %&

Hkkjr dh Lorærk l s i w Z f c V'' k l j d k j u s i f y l v f / k f u ; e 1861 d s } k j k i f y l d k s L F k k u h ; f o f / k & 0 ; o L F k k d s v / k h u f d ; k F k k A i f y l v f / k f u ; e 1861 d h / k k j k 3 d s v u d k j i f y l d k i ; b { k . k j k T ; l j d k j e a f u f g r g k r k g A l f i o / k k u d h v u d p h & 06 e a j k T ; l p h & 02 , o a l f i o / k k u d s v u d N n 162 d s v u d k j i f y l i j v f i r e f u ; æ . k j k T ; l j d k j d k g A f t l i d j . k e a j k T ; l j d k j d k s f o / k k ; h " k f D r ; k a i k l r g s m l i d j . k e a d k ; i k f y d k j k T ; l j d k j d h d k ; i k f y d k e a f u f g r g k s c h A i f y l i j ; g f u ; æ . k x g e æ h d s e k / ; e l s e d ; e æ h } k j k i H k k o h g k r k g S r F k k v l r r k s R o k e d ; e æ h d h v / ; { k r k o k y h e æ h i f j ' k n } k j k f u ; f i = r g k r k g A

dR; %&

i f y l f o H k k x v i j k / k r F k k v i j k f / k ; k a i j v æ d q k y x k d j j k ' V a d s l e l r u k x f j d k a d k s H k o e p r l e k t i n k u f d ; s t k u s d h v f h k / k k j . k k i n d k ; l d j u s o k y k , d v u d k k f ' k r l æ B u g A ; g l f i o / k k u , o a f o f / k d s v u q i u k x f j d k a d s v f / k d k j k a , o a f g r k a d k l j { k d g s b l d s v H k k o e a u k x f j d k a d h l j { k k v F k o k l f i o / k k u d s f u f g r H k k o u k v k a d k s i w k z f d ; k t k u k d n k f i l E H k o u g h a g A

drD; %&

i f y l d k i k F k f e d d r D ; v i j k / k , o a v 0 ; o L F k k d k s j k s d u k g A i f y l d s v k / k k j H k r d r D ; f u E u o r g S %&

- 1& v i j k / k d k f u o k j . k
- 2& v i j k / k ? k f V r g k s u s i j v i j k / k d h f o o p u k
- 3& v i j k f / k ; k a d k s f u :) d j u k
- 4& U ; k ; k y ; k a e a v f h k ; k s t u
- 5& " k k a r & 0 ; o L F k k d k v u j { k . k

fclnq l ð ; k & 02

v f / k d k f j ; k @ d e p k f j ; k a d h " k f D r ; k , o a d r D ; t u i n l r j i j

ofj'B i f y l v / k h { k d %&

o f j ' B i f y l v / k h { k d] f t y s d k i æ d k g k r k g A ; g c y d h n { k r k j } v u d k k l u v k s d r D ; k a d s l e p r i k y u d j k u s d s f y , m R r j n k ; h g A m l u g a ; g n s k u k g k r k g S f d U ; k ; k y ; k v k s v l ; l { k e i k f / k d k f j ; k a d s v k n s ' k k a d k r R d k y f d z k l l o ; u g k s j g k g S v F k o k u g h A

o f j ' B i f y l v / k h { k d d k s d k u n u & 0 ; o L F k k , o a " k k a r & 0 ; o L F k k c u k ; s j [k u s g r q v k b D i h 0 l h 0 @ l h 0 v k j 0 i h 0 l h 0 @ f o f h k l u v f / k f u ; e k a r F k k f o f / k } k j k L F k k f i r l H k h f u ; e k a d k i k y u d j k ; s t k u s g r q l e l r v f / k d k j i k l r g A b l d s v f r f j D r e d ; v k j { k h r d d s d f e z k a d k f u ; q D r i k f / k d k j h g k s u s d s d k j . k m l u g a i j P ; r @ f u y f e c r f d ; s t k u s d k v f / k d k j H k h i k l r g A

ofj'B ifyl v/kh{k d svfrfjDr vU; vf/k@deD dh "kDr; k vU drD; %&

dD l 0	dk; Z dh i dfr	l EcfU/kr drD;
1&	vij ifyl v/kh{k d	1& vius {ks=ku=xr dkuu@ "kkar 0; oLFkk dh fLFkr cuk; s j [kukA 2& vij/kka dk i; bsk.k djukA 3& ifyl ykbU@ ifyl dk; ky; l s l EcfU/kr , s l eLr dk; ka dk l Eiknu djuk] ftUgafd; s tkus grq ofj' B ifyl v/kh{k d }kjk ikf/kdr fd; k x; k gks A 4& ifyl mi k/kh{k d fdl h , s dk; Z dk ikyu dj l dsx ft l s og fdl h fof/k ; k fu; e ds }kjk Lo; agh djus dks ck/; u gks A 5& os tkp vU fl Qkfj" k dj l drs gD]pkgs rc og vare vknS" k djus dk l " kDr u gka 6& n.M dsekeyka ea og ogn n.M , oafuyEcu ds vfrfjDr os v/kh{k d ds drD; ka dk ikyu djus dks l " kDr gka 7& ifyl vf/kfu; e dh /kkjk 39 , oa 30& , ds v/khu ofj' B ifyl v/kh{k d ds l Hkh drD; ka dk ikyu djus dks l " kDr gA 8& vU; fofo/k dk; A
2&	ifyl mi k/kh{k d	1& vius {ks=ku=xr dkuu@ "kkar 0; oLFkk dh fLFkr cuk; s j [kukA 2& vij/kka dk i; bsk.k djukA 3& ifyl ykbU@ ifyl dk; ky; l s l EcfU/kr , s l eLr dk; ka dk l Eiknu djuk] ftUgafd; s tkus grq ofj' B ifyl v/kh{k d }kjk ikf/kdr fd; k x; k gks A 4& ifyl mi k/kh{k d fdl h , s dk; Z dk ikyu dj l dsx ft l s og fdl h fof/k ; k fu; e ds }kjk Lo; agh djus dks ck/; u gks A 5& os tkp vU fl Qkfj" k dj l drs gD]pkgs rc og vare vknS" k djus dk l " kDr u gka 6& n.M dsekeyka ea og ogn n.M , oafuyEcu ds vfrfjDr os v/kh{k d ds drD; ka dk ikyu djus dks l " kDr gka 7& ifyl vf/kfu; e dh /kkjk 39 , oa 30& , ds v/khu ofj' B ifyl v/kh{k d ds l Hkh drD; ka dk ikyu djus dks l " kDr gA 8& vU; fofo/k dk; A
3&	fujh{k d@mi fujh{k d	1& Fkkuk i Hkkjh ds : i ea l eLr vf/kdkfj; ka , oa mRrjnkf; Roka dk fuoGuA 2& {ks= ea dkuu , oa "kkar 0; oLFkk dh fLFkr cuk; s j [kukA 3& vij/kka dh foopuk l EcfU/k dk; A 4& fof/k }kjk l e; & l e; ij LFkfi r vf/kfu; eka@ vkbDi hOl hO@ l hvkj i hl h vkfn ea fufgr "kDr; k dk iz xsk djukA 5& mPpkf/kdkfj; ka }kjk l e; l e; ij fn; sx; s idj .kka ea tkp vk[; k i Lr djuk A

		<p>6& mPpkf/kdkfj; ka }kjk l kš s x; s dk; kã dk l Eiknu djukA</p> <p>7& mPpkf/kdkfj; ka l s i k l r f n" k k &funž' kka @vknš' kka dk vuqkyu l fuf" pr djukA</p> <p>8& l Hkh egRo i w k l l p u k v k a , o a v i j k / k ? k f V r g k s u s d h l p u k r R d k y m P p k f / k d k f j ; k a d k s n s u k v k f n A</p>
4&	i z k k u y [k d ½ g d d k 0 ½	<p>1& Fkkus ea f j d k M Z d h i j o y [k i k y d k d k ; Z d j u k A</p> <p>2& t u j y M k ; j h v k s v i j k / k a d h i F k e b f R r y k f j i k M Z f y [k u k A</p> <p>3& v a s t h @ f g l n h e a j k d M + c g h v k s n h j h y s [k k i l r d a c u k ; s j [k u s r F k k F k k u s e a g k s u s o k y s l H k h l j d k j h / k u v k s e w ; o k u l E i f R r d k s l g f { k r v f H k j { k k e a j [k u k A</p> <p>4& x k e p k s d n j k a d h m i f l F k r d k m u d s c k M k s i j v f H k f y f [k r d j u k v k s v i s { k r g k s u s i j m u d h i l r d k s a e a i f o ' V ; k a d j u k A</p> <p>5& v k j f { k ; k a d k s i f y l x t V v k s f d f e u y b l V s y h t b l x t V d h v f H k l p u k v k a v k s , d s v l ; d k x t k a d k s f t l g a H k k j l k / k d v f / k d k j h p a s] t k j & t k j s l s i < d j l p u k u k A</p> <p>6& f o o j . k k p o r u i = d v k s o r u l k s l a d f y d d j u k j f t L V j r s k j d j u k v k s v l ; f y f i d h ; d k ; Z d j u k j t k s m l s H k k j l k / k d v f / k d k j h } k j k l e u m f " k r f d ; k t k o A</p> <p>7& l H k h i l r d a @ v f H k y s [k k a d k s j [k u k A</p> <p>8& m i j k D r d s v f r f j D r F k k u k i H k k j h } k j k f n ; s x ; s v l ; d k ; A</p>
5&	vkj {kh	<p>1& v i j k / k d k s ? k f V r g k s u s l s j k s d u k A</p> <p>2& l a r j h M ; w h d s l e ; g o k y k r e a c f n ; k p f r t k j h e k y [k k u s v k s d h l H k h l E i f R r ; k a d h j { k k d j u k A</p> <p>3& v i u h c h V l E c l u / k h l p u k v k a d k l a d y u] c h V c a d e a m u d k v a d u d j u k v k f n A</p> <p>4& m P p k f / k d k f j ; k a } k j k f u x ž r f u n ž ' k k a d k i k y u d j u k A</p>
6&	v f H k l p u k b d k b z e a f u ; D r l H k h d e h z ½ y f i d @ p r f i z J s k h d k s N k M e d j ½	<p>1& v f H k l p u k v k a d k l a d y u A</p> <p>2& f o n s ' k h u k x f j d k s d k v k o k x e u i j n f ' V j [k u k A</p> <p>3& t u i n e a i p f y r l e l r x f r f o f / k ; k a i j n f ' V j [k u k r F k k ; F k k l e ; l p u k l E c l u / k r m P p k f / k d k f j ; k a d k s i f ' k r d j u k A</p> <p>4& i k j i = k a @ p f j = l R ; k i u k a d h t k p d j u k A</p> <p>5& m i j k D r d s v f r f j D r m P p k f / k d k f j ; k a } k j k l e ; & l e ; i j i k l r g k s u s o k y s f n " k k & f u n ž ' k k a d k v u q k y u A</p>
7&	f j t o z f u j h { k d @ m i f u j h { k d	<p>1& l H k h j { k d k a v k s e k x j f { k ; k a d k f u j h { k . k d j u k r F k k ; g n s [k u k f d o g v i u a d r D ; k a l s i w k z : i l s i f j f p r g s v F k o k u g h a</p> <p>2& f u ; f e r : i l s i j M d j u k r F k k ; g n s [k u k f d m u d s i k l l E i w k z f d V g s v F k o k u g h a</p> <p>3& i f y l y k b z e a d r D ; k a d s l g h f o r j . k i j n f ' V j [k u k A</p> <p>4& f j t o z d s o " = k a v k ; k k a] x k s y k & c k : n] M j k a v k s H k . M k j k a d h l g f { k r v f H k j { k k , o a j f t L V j k a d k j [k j [k k o d j u k A</p> <p>5& j a x : V k a d s i f " k { k . k r F k k v H ; k l d j k u s d s f y , m R r j n k ; h</p>

		<p>gkukA</p> <p>6& okf'kd Qk; fja ds l e; Lo; ami fLFkr jgukA</p> <p>7& vkdfLed : i l s xknk dk fujh{k.k djuk rFkk dkskky; es xksyk ck: n vks gokykr ea ejka ifjn" kZu djsk rFkk bl dh fVli .kh vko" ; d vfHkys[kka ea ntZ djukA</p> <p>8& bl ds vfrfjDr ifyl v/kh{kd }kjk fuxZr vkns" kka dk ikyu djskA</p> <p>9& fjtoZ fujh{kd fdl h vkj{kh dks vf/kdre 03 fnol ds fy; s 0; k; ke vks Fkd n s okys drD; ka dk n.M ns l drk gA</p>
8&	ed; vkj{kh l Oi q	<p>1& xknZ vks exZ j {k dks dks de; M djus 0; k; ke es vuqns" k ns l drk gA</p> <p>2& xknZ dek.Mj ds : i ea fofHku LFkkuka dh l j {kk grqfu; q r fd; k tk l drk gA</p> <p>3& egRoi wkZ 0; fDr; ka dh l j {kk ea xuj ds : i ea fu; q r fd; k tk l drk gA</p> <p>4& bl ds vfrfjDr mPpkf/kdkfj; ka }kjk l e; &l e; ij i klr fn" k&funz" kka dk vuqkyuA</p> <p>5& ; krk; kr Mz W h ea fu; q r fd; k tk l drk gA</p>
9&	vkj{kh l Oi q	<p>1& fofHku l j {kk xknk ea l j {kk grqfu; q r fd; k tk l drk gA</p> <p>2& " kkr 0; oLFkk Mz W h ea fu; q r fd; k tk l drk gA</p> <p>3& ; krk; kr fu; a.k Mz W h ea fu; q r fd; k tk l drk gA</p>
10&	ed; vkj{kh , e0 Vh0	<p>1& tuin ea mi yC/k okguka dh ns[kj[k djuk A</p> <p>2& okguka ds l Ecl/k ea i wkZ vfHkys[k j [kukA</p> <p>3& , eVh dk; kZy; l Ecl/kh l eLr vfHkys[kka dk j [k&j [kko A</p>
11&	vkj{kh pkyd	<p>1& okguka dk l pkyuA</p> <p>2& okguka dh ns[kj[k Ka</p>
12&	ed; vkj{kh vkjekj j	<p>1& " kL=ka dk vko" ; Drkuq kj forj.k rFkk mudh l kQ l QkbZ dk /; ku j [kukA</p> <p>2& forfjr fd; s x; s "kL=ka dk fujh{k.k djukA</p> <p>3& " kL=kxkj ea mi yC/k l Hkh izdkj ds vfHkys[kka dh ns[k ns[k djukA</p>
13&	vkj{kh vkjekj j	<p>1& ed; vkj{kh vkjekj j dh l gk; r djukA</p>
14&	jSM; ks "kk[kk	<p>1& tuin ds l Hkh Fkkuka l syxkrkj l E i dZ LFkkfir fd; k tkukA</p> <p>2& l pkj l Ecl/kh midj .kka dk j [k&j [kko djukA</p> <p>3& fofHku l pukvka dk l a s k.k djukA</p> <p>4& dk; kZy; ea mi yC/k vfHkys[kka dk j [k&j [kko djukA</p>

15&	i/zkku fyfi d/e; l gk; dka d½	1& ckgjh tuin l sgks okyh l eLr i = 0; ogkj grqmRrjnk; h gA 2& ifyl dfez ka ds l vfkHkys [kka dk j [k&j [kkoA 3& n.M@oru@i s' ku@l R; ki u l Ecl/kh dk; A 4& mijkDr ds vfrfjDr vU; l Hkh iz' kkl fud dk; k3 dk l Ei knu rFkk mPpkf/kdkfj; h }kjk fuxr funz' kka dk vuqkyuA
16&	vkfidd/e; l gk; dka ds ½	l Hkh izkj ds vkgj.k@forj.k l Ecl/kh dk; A
17&	vk" kfyfi d	1& ofj' B ifyl v/kh{kd ds xki uh; l gk; d ds : i ea dk; l djrs gA xki uh; idfr ds l Hkh vkns' kka@funz' kka@i z =ka dks l jf{kr j [kukA 2& ofj' B ifyl v/kh{kd }kjk fuxr funz' kka dk vuqkyuA
18&	okpd /e; l gk; dka d½	1& tuin ds vij/kka l Ecl/kh l Hkh izkj ds vfkHkys [kka dk j [k&j [kkoA 2& mPpkf/kdkfj; ka@ofj' B ifyl v/kh{kd }kjk fuxr funz' kka dk l i s k. kA

fclnql d; k &03

fofu" p; djus dh ifdz k ea ikyu dh tkus okyh ifdz k] ftl ea i; bsk.k , oa
mRrjnkf; Ro ds ek/; e l Eefyr gs %&

ofj' B ifyl v/kh{kd %&

- 1& ftyk Lrj ij iklr l Hkh izj.kka ea vfire fu.kz fy; k tkukA
- 2& tuin ea gks okys vij/kka@ fujkklRed dk; bkg; ka dh ekfl d l ehkk djukA
- 3& tuin ds l Hkh Fkuka@pkd; ka@ " kk [kkvka dk fujh{k.kA
- 4& ifyl ds l Hkh vf/kdkfj; ka@depkfj; h ds dk; ka dk i; bsk.k rFkk vfrfjDr mRrjnkf; Roka
dk fu/kkj.kA
- 5& foRrh; ekeyka ea vfire fu.kz yuka
- 6& ifyl dfez ka ea vuq' kkl u , oafu; a.k cuk; sj [kukA
- 7& ifyl dfez ka dh l d k l fo/kk dk /; ku j [kukA
- 8& i s' ku@n.M@oru@l R; ki u vkfn dk; k3 dk l Ei knu djokukA
- 9& vfhkl puk "kk [kk l s iklr l puk dk fo" ysk.k djuk rFkk vko" ; d funz' k fuxr
djukA

vij ifyl v/kh{kd %&

- 1& vi us {ks=klr}r es ?kfVr vijk/ka dk i ; b{k.k djukA
- 2& fo" ksk vijk/k vk[; k Hkst ukA
- 3& ngst vf/k0@vu@ tifr@tutkfr vf/k0 vkfn eafoopuk djukA
- 4& ofj'B ifyl v/kh{kd }jk for l EclU/h vf/kdkj iklr gks ij vkgj.k@forj.k dk dk; Z djukA
- 5& fofHklu "kk [kkvka ds fujh{k.k.@i ; b{k.k dk dk; Z djukA
- 6& fofHklu i kFkZuk&i=ka dh tkp vkfn djukA

ifyl mi k/h{kd %&

- 1& vi us {ks=klr}r es ?kfVr vijk/ka dk i ; b{k.k djukA
- 2& fo" ksk vijk/k vk[; k Hkst ukA
- 3& ngst vf/k0@vu@ tifr@tutkfr vf/k0 vkfn eafoopuk djukA
- 4& ofj'B ifyl v/kh{kd }jk for l EclU/h vf/kdkj iklr gks ij vkgj.k@forj.k dk dk; Z djukA
- 5& fofHklu "kk [kkvka ds fujh{k.k.@ i ; b{k.k dk dk; Z djukA
- 6& fofHklu i kFkZuk&i=ka dh tkp vkfn djukA

Fkkuk Lrj ij %&

- 1& vijk/ka dh jkdFkke djukA
- 2& vijk/k ?kfVr gks ij vukoj.k djuk rFkk vkjki &i = U; k; ky; i f' kr djukA
- 3& U; k; ky; ea vflk; ks ds fopkj.k ds nksku l kf{k; ka dks mi fLFkr djukA
- 4& U; k; ky; ka ea iklr l Euka@uksV" kka@okj.Vka vkfn dh rkehy djukA
- 5& fgLVh" khVjka ij nf'V j[kukA
- 6& egRoi wZ ?kVukvka ds ?kfVr gks ij rRdky l puk mPpkf/kdkfj; ka dks i f' kr djukA
- 7& fofHklu i kFkZuk&i=ka dh tkp djukA
- 8& mPpkf/kdkfj; ka }jk fuxr funz' kka dk vuqkyu djukA

fclhq l [; k %&4

dR; ka ds fuoZu ds fy, Lo; a }jk LFkfi r eki eku

1/2 ftyk Lrj ij %&

1& vijj/kka fo" kskdj efgykva@cPpk@vu@ tkfr@tutkfr vkfn ds fo:) gkus okys vijj/kka ij jkd yxkuk rFkk mlga ; Fkk" kh?kz U; k; vkfn fnyk; s tkus dks ikFkfedrk nuka

2& vke turk ea ifyl ds ifr fo" okl dh Hkkouk tkxr dj] fe= ifyl dh l dYiuk dks eirZ: i inku djuka

3& fo/kkul Hkk iz' uks dk le; l hek ds vlurZkr mRrj Hkstuka

4& tuin earLdjh ij iwKz isk jkd yxkuka

5& ; krk; kr 0; oLFkk ea l qkkj vkfnA

6& oh0oh0vkbDi h0@oh0vkbDi h0 egkuHkkoka ds vkxeu ij muds Hke.k dh l puk l EcfU/krka dks le; l s Hkstuka

7& fjV ; kfpdkvka ea fu/kkfjr frffk ij "ki Fk i= nkf[ky djuka

8& ifyl foHkkx ea ipfyr fuelZk dk; ka dks fu/kkfjr ekud ds vuq i dj; k tkuka

9& mPpkf/kdkfj; ka l sikr gku okys funZ' kka dk vuqkyu djuka

10& vuq' kkl ughurk djus ij dR; ds vuq kr eagh n.M inku fd; k tkuka

11& ifyl dfeZ ka }kjk vPNs dk; Z djus ij mlga i k&l kfgr djuka

12& i ; kbj.k l j{k.k grq iz kl djuka

13& ifyl dfeZ ka dh l q{k&l fpo/kk dk /; ku j [kuka

fclhq l q; k&5

ykd ikf/kdkjh vFkok muds dkfeZka }kjk vi us dR; ka ds fuoZu ds fy, /kkfjr rFkk iz ks fd; s tkus okys fu; e]fofue; vups' k] funZ' kdk vKj vfhkys[k dh l puk %

¼½ ftyk Lrj ij %

dDl 0	dk; Z dh izlfr	l EcfU/kr fu; e
1&	fofRr; ekey:	1& fofRr; gLr i qLrdk; :
2&	l ok l EcfU/k ekeys	1& fofRr; gLr i qLrdkA 2& l jdkjh depkjh vkpj.k l fgrkA 3& dUVksy Dykfl fQds' ku , .M vihy : Yl A 4& fofHku l ok l oxZ dh l ok fu; ekofy; kA 5& i s' ku fu; eA 6& l keku; Hkfo'; fuoZu fuf/k fu; ekoyhA 7& eSipy vkND xouE s/ vkMjA 8& ifyl jxys' kuA 9& ifyl dk; kZy; eSipyA

		10& ifyl , DVA
3&	dk; kÿ; ifdz k , oa l kekl; i=kpkj	1& " kkl ukns' kka dk l ægA 2& ifyl jxgys' kuA 3& ifyl dk; kÿ; eÿpyA 4& mRrjk[k.M v/khuLFk Js kh ds ifyl vf/k0@deD dh n.M , oa vihy fu; ekoyh&1991]mi kUrj.k vkns' k&2002A
4&	vijk/k dkuu 0; oLFk vkfn l s l EcfU/kr ekeys	1& Hkkjrh; n.M l ãgrk A 2& n.M ifdz k l ãgrkA 3& l k; vf/kfu; eA 4& jkT; l jdkj@Hkkjr l jdkj }kjk l e; &l e; ij cuk; s x; s vf/kfu; eA 5& ifyl vf/kfu; eA 6& " kkl u }kjk fu/kkZjr uhfr; kA

fclhq l ã; k&6

, ð s nLrkost ka ds tks muds }kjk /kkfjr ; k muds fu; æ.kk/khu g\$ i oXkã dk fooj.k%&

¼½ ftyk Lrj ij %&

i=kofy; ka dk j [k&j [kko fyfi d oXh; deþkfj; ka ds }kjk l Ei kfnr fd; k tkrk g\$ tks fd vi us mPpkf/kdkjh ds fu; æ.k , oa i ; b\$ k.k ea vfHkys [kka dk j [krs gã rFkk dk; bkg h djrs gSA i=kofy; ka ij dk; bkg h gkus ds i" pkr l EcfU/kr deþkj; ka }kjk vfHkys [kkxkj ea ml dh mi ; k\$ xrk ds vuq kj "kkl u ds fn" kk funs' kka ds de ea fofHkUu vof/k; ka ds fy, l ãpr fd; s tkrsgA bu vfHkys [kka dh fuEu J\$.k; ka g\$&

1& fofHkUu idj.kka , oa fo'k; ka dh i=kofy; kA

2& fofHkUu iftdk; A

¼½ Fkkuk Lrj ij %&

Fkkuk Lrj ij fofHkUu idkj ds jftLVjka , oa vfHkys [kka dks mi ; kx ea yk; k tkrk g\$ ftuea l siæ[k fuEuor g\$%&

1& eQ: j jftLVj

2& mu HkxkM\$ vijkf/k; ka ds ckjs ea tks i kUr; l p h ij u g\$ dh l p ukvka dk jftLVjA

3& jksdM+cgh

4& i " kq fcdh

5& i " kq/ka dk vokjk gksuk A

- 6& vkjksi i =
- 7& ifyl ,DV dh /kkjk 34 ds vlrkr vkjksi &i =
- 8& Hkktu]/ku bR; lfn dsfy, vfxe dh ifri firZ dh pd cpl
- 9& I puk ifji =ka dh Qkbzy
- 10& vuqs" k ifji =
- 11& n.M ifdz; k I fgrk dh /kkjk 432 ds v/khu I " krZ mlekSpr vf/kdkjh
- 12& n.M ifdz; k I fgrk dh /kkjk 356 ds vknS" kka ds v/; k/khu nks kfl)
- 13& I klrkfgd xki uh; Mk; jh
- 14& vij/k jftLVj
- 15& vij/k vfkys k i rd xte pdkh nkj ½
- 16& xte vij/k uk/ cpl
- 17& vij/kh tutkfr; ka dh jftLVj "khV
- 18& vij/kh tutkfr; ka vf/kO dsfu; e&4¼ ½ ds v/khu jftLVh dr 0; fDr; ka dh I pphA
- 19& vij/kh o tutkfr; ka ds l nL; ka ds vYidkyhu ifjR; kx ij i =
- 20& eR; qjftLVj
- 21& iklrdrkZ jftLVj
- 22& ds" k Mk; jh
- 23& tujy Mk; jh
- 24& n0iDI @dh /kkjk 173 ds v/khu vfire fj i ks/Z
- 25& vaxy Nki jftLVj
- 26& I Ks vij/k/ka dsfy, ¼ Eke I puk fj i ks/½
- 27& vl Ks vij/k/ka dsfy, ¼ Eke I puk fj i ks/½
- 28& fxjkg jftLVj
- 29& ejEer dsfy, vfxe dk fgl kc
- 30& tkp i fpZ ka ds vu plef.kdk **v^
- 31& tkp i fpZ ka ds vu plef.kdk **c^

- 32& fgLVh" khV dh vuϕef.kdk
- 33& eR; wI eh{kk fj i kS/Z
- 34& fujh{k.k i qLrdk ¼vaxst h½
- 35& fujh{k.k i qLrdk ¼fglnt h½
- 36& eftLVV dsfy, fujh{k.k i qLrdk
- 37& dkxtka dk chtd
- 38& n0i 0I 0 dh /kkjk 55 ds v/khu fxjlrkjh vkns" k
- 39& n0i 0I 0 dh /kkjk 109 ds v/khu dk; ɔkgh
- 40& n0i 0I 0 dh /kkjk 110 ds v/khu dk; ɔkgh
- 41& plsjh vks i q% i klr dh xbZ I Ei fRr vkfn ds I Ecu/k ea jftLVj
- 42& vU; i fyi Fkkus dh plsjh dh xbZ I Ei fRr ds ckjs es vkns" k dh Qkbȳ
- 43& fjek.M "khV
- 44& Fkkus dh vkns" k i qLrdk
- 45& n0i 0I 0 dh /kkjk 160¼1½ dh v/khu tkjh fd; s x; s I Eeuka ds : i ea vkokgu i =A
- 46& jktif=r vf/kdkjh }kjk vuϕksnr I anX/k 0; fDr; ka dh I p hA
- 47& dks kky; dh i kl cϕ
- 48& ?kϕDdM+ tutkfr; ka vks fxjkg
- 49& dks jftLVj vks ik: i fofo/k i qrdk grq
- 50& Qkbȳ i qrd tle I Ecu/khA

fclnq I ȳ; k&07

fdl h 0; oLFkk dh fof" k'V; ka tks ml dh ufr ds I j puk ; k ml ds dk; k lo; u ds I Ecu/k ea turk ds I nL; ka l s i jke" kZ ds fy, ; k muds }kjk vH; konu ds fy, fo | eku gA

¼½ ftyk Lrj ij %&

- 1& tuin ea vk; kstr foHkUu cBdk ea Hkx fy; k tkrk gS rFkk i klr gkus okys I ϕkoka ij dk; ɔkgh dh tkrh gA
- 2& tu&ifrfuf/k; ka] i fyi i a' kul I i =dkjh] ehfM; k ds 0; fDr; h , oa turk ds 0; fDr; ks l s l e; & l e; ij xks' B; ka dh tkrh gS xks' B; ka ds vfrfjDr Hkh vke turk ds I kFk fopkjka dk vknku&inku fd; k tkrk gS buea mBkbZ tkus okyh l eL; kvka dk rRdky fuokj.k fd; k tkrk gA

3& i f y l d f e z ; k a g r q H k h v y x l s l E e y u v k ; k s t r f d ; s t k r s g A

¼½ Fkkuk Lrj ij %&

1& Fkkuk Lrj ij Fkkuk i H k k f j ; k a } k j k l e ; & l e ; i j x k e l j { k k l f e f r ; k a @ e k j Y y k l j { k k l f e f r ; k a @ v k e t u r k @ 0 ; k i k f j ; k a @ V k l i k s / l @ V D l h ; f u ; u v k f n d s l k f k x k s ' B ; k a v k ; k f t r d h t k r h g s r f k k l e l ; k v k a d k f u j k d j . k f d ; k t k r k g A

2& ; f n m D r x k s ' B ; k a e a m B k b z x ; h l e l ; k ; a i f y l f o H k k x l s l E c f u / k r u g h g k r h g s r k s m l u g a f u l r k j . k g r q l E c f u / k r f o H k k x k a d k s H k s t f n ; k t k r k g A

fclnq l ¼ ; k & 8

, d s c k s / k a i f j ' k n k a j l f e f r ; k a v k s v l u ; f u d k ; k a d s f o o j . k j f t u e a n k s ; k v f / k d 0 ; f D r g s f t u d k m u d s H k k x : i e a ; k b l c k j s e a l y k g n u s d s i z k s t u d s f y , x B u f d ; k x ; k g s f d D ; k m u c k s / k a i f j ' k n k a l f e f r ; k a v k s v l u ; f u d k ; k a d h c B d a t u r k d s f y , [k y h g l o x h ; k , d h c B d a d s d k ; b R r r d t u r k d h i g p g k s c h A

¼½ ftyk Lrj ij %&

ftyk / k d k j h e q ; f o d k l v f / k d k j h , o a m i f t y k / k d k j h v k f n } k j k v k ; k s t r x k s ' B ; k a e a H k k x f y ; k t k r k g A f o f H k k u l y k g d k j l f e f r r f k k t u i n L r j h ; c B d k f t u e a f o f H k k u L r j d s i f r f u f / k i f r H k k x d j r s g s f t y k / k d k j h } k j k v / ; { k r k d h t k r h g s f t u e a t u i f r f u f / k ; k a } k j k i f r H k k x f d ; k t k r k g s r f k k b u d k d k ; b R r t u i f r f u f / k ; k a r d i g p r k g A

¼½ Fkkuk Lrj ij %&

1& Fkkuk Lrj ij v k ; k s t r g k s u s o k y h c B d k a e a i = d k j k a @ e h f M ; k d f e z ; k a @ t u r k , o a m u d s i f r f u f / k H k k x y r s g s r f k k e a m B k b z t k u s o k y h l e l ; k v k a d k ; F k k l E h k o r R d k y f u l r k j . k d j f n ; k t k r k g A

fclnq l ¼ ; k & 9

egRoi w k z i n k a i n f u ; p r v f / k d k f j ; k a , o a d e p k f j ; k a d h f u n s " k d k % &

tuin ngjknw esfu; p r v f / k d k j h ; k a d s e k s b y u e c j k s d h l p h				
d0 l 0	uke v f / k d k j h , o a		ekskby u0	dk; ky;
	in			
1	Jh th0, u0xkkokeh	ofj "B i f y l v / k h { k d	9411112706	2716203-09
2	Jh t l o l l r f l g	v i j i f y l v / k h { k d u x j	9411112725	2716207
3	Jh th0, l 0 / ; k u h	v i j i f y l v / k h { k d x t e h . k	9412057177	
4	Jh v t ; t k s k h	i f y l v / k h { k d ; k r k ; k r	8650666100	
5	Jherh ' o r k p k s s	{ k s = k f / k d k j h M k y u o k y k	9411112993	
6	Jh v h o m h o c s y k	{ k s = k f / k d k j h _ _ f " k d s k	9411112752	2432200

7	Jherh l fjr k Mkkky	{ks=lf/kdkjh l nj	9411112089	
8	Jh ef.kdklr fejk	{ks=lf/kdkjh ; krk; kr	9411113990	2101021
9	Jh fxjh'k pln	{ks=lf/kdkjh fodkl uxj	9411112745	1360222100
10	Jh i ælnz fl g Mkkky	{ks=lf/kdkjh dkr okyh	9411112759	
11	Jh uouhr dækj	{ks=lf/kdkjh i Vsyuxj	9411111959	
12	Jh yfyr ekgu mirh	{ks=lf/kdkjh ug; dkykuh	9450401571	
13	Jh enu fl g Ql bk.k	{ks=lf/kdkjh el yjh	9411112751	
14	Jh fnušk pln	i Hkkjh fujh{kd&dkr okyh	9411112809	2716216
15	Jh fnušk k Hk.Mkjh	i Hkkjh fujh{kd&Mkyuokyk	9411112814	2716218
16	Jh , l 0, l fo"V	i Hkkjh fujh{kd&i Vsyuxj	9411112825	2716219
17	Jh vjfoln fl g jkor	i Hkkjh fujh{kd cl lr fogkj	9411112824	2716222
18	Jh jfolnz dækj	i Hkkjh fujh{kd&_f"kdšk	9411112815	2430100
19	Jh ijh{kr dækj	i Hkkjh fujh{kd&Fkkuk el yjh	9411112817	2716227
20	Jh včy fl g jkor	i Hkkjh fujh{kd&Fkkuk dSV	9411112810	2716235
21	Jh xtlnz fl g jkšyk	i Hkkjh fujh{kd&Fkkuk Mkbškyk	9411112818	2716230
22	Jh MHO, l 0jkor	i Hkkjh fujh{kd&fodkl uxj	9411112819	01360&250342
23	Jh v" kkd R; kxh	Fkkuk/; {k&jkt ij	9411112811	2716224
24	Jh i nhi jk.kk	Fkkuk/; {k dyeuVkmu	9411112812	2716221
25	Jh jktšk 'kkg	Fkkuk/; {k&jk; okyk	9411112822	2484239
26	Jh l q z Hkk.k usch	Fkkuk/; {k&l gl ij	9411112816	2716231
27	Jh jfodækj	Fkkuk/; {k&jk; ij	9411112823	2716225
28	Jh vejthr fl g	Fkkuk/; {k&ug; dkykuh	9411112991	2673117
29	Jh vkjOihOl rh	Fkkuk/; {k&t hOvkjOih	9411112921	2716223
30	Jh jktho jkškk.k	Fkkukv/; {k jkuhi kškjh	9411112826	2416235
31	Jh i d t i kškfj; ky	Fkkuk/; {k&dki l h	9411112820	01360-275076
32	Jh eukst jkor	Fkkuk/; {k&pdjkrk	9411112813	01360-272222
33	Jherh fdju vl oky	i Hkkjh&efgyk gV i ykbZ	9410354779	2716239
34	Jh e.kh Hkk.k JhokLro	i Hkkjh&, l 0vko thO	9411112963	&
35	Jh cl Urh yky e/koky	i Hkkjh , yvkbZ w	9411112796	2710108
36	Jh ; kxlnz fl g	i škdki , l 0, l Oi hO	9719016131	
37	Jh jkds' k xq kbZ	i hOvkjOvkš , l 0, l Oi hO	9917119222	
38	Jh jkds' k nøyh	ifr l kj fujh{kd i ty l ykbZ		0135&2716226

fcUnq l Œ; k &10

i R; d vf/kdkjh] dæpkjh }kjk ikr ekfl d] ikfJfed] ft l ea ml ds fofu; eka ea ; Fkk mi cfl/kr ifrdj dh izkkyh l efyr gS%&

¼½ tuin@"kk[k@Fkkuk i Hkkjh Lrj ij dk; j r vf/ko dh funf"kd k %&

DD l @	i nuke	eny oru ¼ i ; ka ek
1-	Ofj' B ifyl v/kh{kd	15600&39100&6600

2-	vij ifyl v/kh{kd	15600&39100&6600
3-	ifyl mik/kh{kd	15600&39100&4600
4-	fujh{kd	9300&34800&4600
5-	mi fujh{kd	9300&34800&4200
6-	ifrl kj fujh{kd	9300&34800&4600
7-	fujh{kd vfilkl p̄uk bdkb.	9300&34800&4600
8-	fujh{kd jSM; k	9300&34800&4600
9-	vkj0 , e0 vk0	9300&34800&4200
11-	vkj0 , l 0 vk0	9300&34800&4200
12-	l h0 , Q0 vk0	15600&39100&5400
13-	, Q0 , l 0 vk0	9300&39100&4200
14-	izkku fyfi d	9300&39100&4200
15-	vk" kfyfi d	9300&39100&4200
16-	Vkidd	9300&39100&4200
17-	l gk; d fyfi d	5200&20200&2400
18-	eŋ; vkj {kh	5200&20200&2000
19-	dkfu0	5200&20200&1900
20-	prŋkz Js kh	5200&20200&1800

1/2 tuin esifyl cy dk l Eiwk Lohdr fu; ru fuEuor gS%

Ø0 tuin inuke l Ø			Lohdr fu; ru	mi yC/krk	vud fpr tkfr		vud fpr tutkfr		fi NMh tkfr		eflye tkfr		fi D[k		bl kbz		
1	2	3	4	5	mi yC/k	ifr0	mi yC/k	ifr0	mi yC/k	ifr0	mi yC/k	ifr0	mi yC/k	ifr0	mi yC/k	ifr0	
V	ngjknw	ukxfjd i fyl															
1		ofj"B i fyl v/kh(kd	1	1	0	0	0	0	0	0	0	0	0	0	0	0	0
2		vij i fyl v/kh(kd	2	3	0	0	0	0	0	0	0	0	0	0	0	0	0
3		i fyl mi/kh(kd	6	9	0	0	0	0	0	0	0	0.0	0	0	0	0	0
4		fujh(kd ukOi Ø 1/2Male½	8	11	0	0	0	0.0	1	9.1	0	0	0	0	0	0	0
5		efgyk fujh(kd ukOi Ø 1/2femal½	0	0	-	-	-	-	0	#DIV/0!	-	#VALUE!	-	#VALUE!	-	#VALUE!	#VALUE!
6		mOfujh0 ukOi Ø @th0vki0i h0 l fgr 1/2Male½	193	173	28	16	4	2.3	15	8.67	2	1.2	3	1.7	0	0	0
7		efgyk mOfujh0 ukOi Ø 1/2femal½	1	27	4	15	0	0	2	7.41	0	0	0	0	0	0	0
8		g0dk0 ukOi Ø @ th0vki0i h0 l fgr 1/2Male ½	180	142	37	26	3	2.1	15	10.56	1	0.7	0	0	0	0	0
9		efgyk g0dk0 ukOi Ø 1/2femal ½	10	11	1	9	2	18	0	0	0	0	0	0	0	0	0
10		dkWl 0 ukOi Ø @th0vki0i h0 l fgr 1/2Male ½	1527	1263	299	24	32	2.5	400	31.67	28	2.22	4	0.3	0	0	0
11	efgyk dkWl 0 ukOi Ø 1/2femal ½	113	238	49	21	9	3.8	45	18.91	4	1.68	4	1.7	0	0	0	
C		l 'kl= i fyl															
12		ifrl kj fujh(kd	1	1	-	-	-	-	-	-	-	-	-	-	-	-	#VALUE!
13		mi fujh(kd l 'kl= i fyl (SIAP)	6	4	2	50	0	0.0	-	-	-	-	-	-	-	-	#VALUE!
14		g0dk0 l 0i Ø 1/2AP 1/20@'kM/1/29½	102	153	32	21	0	0.0	7	4.58	1	0.65	0	0	0	0	0
15		dkWl 0 l 0i Ø 1/2AP 1/222½@dkWl 0 'kM/1/247½	383	381	98	26	8	2.1	103	27.03	0	0	0	0.0	0	0	0
16		dkWl 0 fcxyj 1/2BIGULAR½	4	5	1	20	-	-	-	-	-	-	-	-	-	-	-
17		mi fujh(kd v/; ki d 1/2SI TEACHER ½	1	1	0	0	0	0	0	0	0	0	0	0	0	0	0
18		g0dk0 vkbDVh0vkbD 1/2ITI ½	2	2	0	0	0	0	-	-	-	-	-	-	-	-	-
19		g0dk0 i h0vki0i h0 1/2PTI ½	1	1	-	-	-	-	-	#####	-	-	-	-	-	-	-

I		vkjekj l oxi														
20		mi fujh(kd vkjekj ¼ARM ½	2	1	0
21		gðdk0 vkjekj ¼ARM ½	2	2
22		dWl 0 vkjekj ¼ARM½	4	5	1	20	.	.	-	#####
n		; krk; kr i fyl														
23		; krk; kr fujh(kd	1	4
24		; krk; kr mi fujh(kd ¼TSI ½	3	10	1	10	.	.	3	30.00
25		gðdk0 ; krk; kr ¼TP ½	12	20	4	20	.	.	-	#####
26		dWl 0 ; krk; kr ¼TP½	100	148	21	14	.	.	14	9.46
p		cÉcfMLi kst y LDokM														
27		mi fujh(kd cÉc fMLi ky¼BD ½	1	1	1	100
28		gðdk0 cÉc fMLi kst y LDokM¼BD½	7	4	1	25
		dk0 cÉc fMLi kst y LDokM ¼BD ½		2	2	100										
N		'oku ny														
29		dWl 0 'oku ny ¼DOG SQUARD½	0	4
t		?kMl okj i fyl														
30		mi fujh(kd ?kMl okj i fyl ¼MP½	1	1
31		gðdk0 ?kMl okj ¼MP ½	2	2
32		dWl 0 ?kMl okj ¼MP½	10	8	3	38	1	12.5	2	25.00	0	0
>	ngjknw	ifjogu 'kk[kk														
33		m0fu0 ifjogu	1	1	1	100
34		gðdk0 ifjogu	1	1	.	0	1	100
35		dWl 0 pkyd ¼thvkj i hÉc fMLi kst y] vñkl puk bdkb¼Mkk LDokM l fgr½	65	72	22	31	2	2.8	18	25.00	0	0
36		dWl 0 Mh0vkj ¼ fMLi p jkbMj ½	1	.	.	0	#DIV/0!	.	#DIV/0!	.	#DIV/0!
37		rduhdhf'k; u , 0, l 0vkbD	.	1	0	0
38		rduhdhf'k; u gðdkWl 0	.	4	2	50
39		rduhdhf'k; u dWl 0	.	10	0	0	.	.	4	40.00	4	40

V	fyfid l oxl															
40	, l 0vkbD¼ e½ ¼HEAD CLERK½	1	1	0	0	0	0	0	0	0	0	0	0	0	0	0
41	, l 0vkbD¼ e½ ¼ACCTT ½	1	1	0	0	0	0	0	0	0	0	0	0	0	0	0
42	, l 0vkbD¼ e½ ¼CASHER ½	1	0	0	#DIV/0!	0	#DIV/0!	0	#DIV/0!	0	#DIV/0!	0	#DIV/0!	0	#DIV/0!	0
43	, l 0vkbD¼ e½ ¼ STENO ½	6	2	0	0	1	50	0	0	0	0	0	0	0	0	0
44	, 0, l 0vkbD¼ e½ ¼Asstt Clerk ¼ gk; d fyfid	15	2	0	0	0	0	0	0	1	50	0	0	0	0	0
45	, 0, l 0vkbD¼ e½ ¼ Asstt.Acctt ¼ gk; d vktidd	6	2	0	0	0	0	1	50.00	1	50	0	0	0	0	0
46	dWl 0¼ e½ ¼ STENO ½	0	2	1	50	0	50	-	#####	0	50	0	0	0	0	0
47	dWl 0¼ e½	1	15	3	20	1	6.67	6	40.00	1	6.67	0	0	0	0	0
48	mnñvupknd	15	18	0	0	0	0	10	55.56	8	44.4	0	0	0	0	0
B	prfkl Jskh															
49	prfkl Jskh¼vfhkl puk bdkbz xlk-k[hj l bl]MKK LDoM]t[hvkvjoi h] i h, eOVh l fgr½	123	126	40	32	3	2.4	8	6.35	1	0.79	0	0	0	0	0
M	ty ifyl															
50	dWl 0 ty ifyl	5	9	0	0	1	11.1	4	0	0	0	0	0	0	0	0
51	ekvj ck/ plyd ty ifyl	2	0	0	0	0	0	0	0	0	0	0	0	0	0	0
<	vfhkl puk bdkbz															
52	ifyl mik/h(kd	1	0	0	0	0	0	0	0	0	0	0	0	0	0	0
53	fujh(kd vfhkl puk bdkbz	2	4	0	0	0	0	0	0	0	0	0	0	0	0	0
54	mi fujh(kd vfhkl puk bdkbz	26	20	5	25	0	0.00	2	10.00	0	0	0	0	0	0	0
55	g0cl0 vfhkl puk bdkbz	21	24	3	13	0	0	3	12.50	1	4.17	0	0	0	0	0
56	dWl 0 vfhkl puk bdkbz	24	40	1	3	0	0	0	0.00	2	5	1	2.5	0	0	0
57	, l 0vkbD¼ e½ ¼HEAD CLERK½	1	1	1	100	0	0	0	0	0	0	0	0	0	0	0
58	, l 0vkbD¼ e½ ¼STENO½	1	0	0	0	0	0	0	0	0	0	0	0	0	0	0
59	, 0, l 0vkbD¼ e½ ¼Asstt Clerk ½	2	2	1	50	0	0	0	0	0	0	0	0	0	0	0
60	dWl 0¼ e½	0	0	0	#DIV/0!	0	#DIV/0!	0	#DIV/0!	0	#DIV/0!	0	#DIV/0!	0	#DIV/0!	0

ngjknw

fclnq l ; k & 11

I Hkh ; kst ukvkā i Lrkforka 0; ; ka vkš dz fd; sx; s l forj dka ij fj i kš/kā dh ifo'V; ka mi nf" kš djrs gq A

vi us i R; d vfhkdj.k dks vkofUVr ctV %&

¼½ 03&ftyk i fyl eq; ds vUrkrA

foRrh; o"l 2010&2011

y[kk'k'kd&2055 i fyl &109 ftyk i fyl &03 ftyk i fyl eq;				
ekud en	foRrh; o"l 2010&11 ea i tr dy vuqku	foRrh; o"l 2010&11 ea dy 0; ;	'kš @ l efi r /kujk'k	0; ; k/ko;
1	2	3	4	5
01 oru	416163000	416162782	218	
02 etnjh	750000	750000	0	
03 egakbz HRRk	146749000	146748245	755	
04 ;k=k HRRk	11500000	11499839	161	
05 LFKukO ;k=k HRRk	350000	348629	1371	
06 vU; HRRs	56604000	56603753	247	
08 dk; ly; 0; ;	1900000	1899995	5	
09 fo r 0; ;	3400000	3399951	49	
10 tydj @tyi Hkj	150000	149992	8	
11 y[ku l kelxh	497000	496979	21	
13 VyhQku	2300000	2299989	11	
16 0; kol kf; d rFK fo'kš l okvka ds fy, Hqarku	25000	24850	150	
17 fdjk; k mi 'k'd	1177300	1177296	4	
23 xqr l ok	170000	170000	0	
25 y?k fuekZk	528645	528645	0	
27 fpfdRI k i fri frZ	1435324	1435282	42	
29 vuj{k.k	248150	248137	13	
42 vU; 0; ;	265000	264996	4	
47 dEl; Wj vuj{k.k	110000	109984	16	
; kx	644322419	644319344	3075	

foRrh; o"l 2010&2011

y[k' k' d & 2055 i f y l & 11 j y o s i f y l & 03 j y o s i f y l e d ;				
elud en	foRrh; o"l 2010&11 ea i l r d y v u q k u	foRrh; o"l 2010&11 ea d y 0 ; ;	' k k @ l e f i r / k u j k ' k	0 ; ; k f / k d ;
1	2	3	4	5
01 osu	3955000	3880166	74834	
03 egxkbZ HRrk	1280000	1347372	0	-67372
04 ; k = k HRrk	165000	164999	1	
05 LFKukO ; k = k HRrk	20000	0	20000	
06 vU; HRrs	429000	428715	285	
08 dk; ky; 0 ; ;	19000	18987	13	
09 fo r 0 ; ;	5000	2386	2614	
11 y[ku l kelxh	12000	11999	1	
13 VyhQku	10000	9990	10	
15 MhO@iO o vuj{k.k	25000	24995	5	
27 fpdfRI k i fri rZ	1000	854	146	
42 vU; 0 ; ;	15000	14951	49	
47 dEl; Wj vuj{k.k	2000	1999	1	
; kx	5938000	5907413	30587	-67372

foRrh; o"l 2010&2011

y[k' k' d & 2055 i f y l & 003 f' k { k v l j i f' k { k . k & 04 i f' k { k . k 0 ; ;				
elud en	foRrh; o"l 2010&11 ea i l r d y v u q k u	foRrh; o"l 2010&11 ea d y 0 ; ;	' k k @ l e f i r / k u j k ' k	0 ; ; k f / k d ;
1	2	3	4	5
01 osu	2650000	2454376	195624	
02 etnjh	5000	4940	60	
03 egxkbZ HRrk	887500	855977	31523	
06 vU; HRrs	267000	260214	6786	
07 ekunş	100000	99931	69	
08 dk; ky; 0 ; ;	150000	149967	33	
09 fo r 0 ; ;	50000	49981	19	
11 y[ku l kelxh	25000	24966	34	
42 vU; 0 ; ;	120000	119997	3	
47 dEl; Wj vuj{k.k	10000	9990	10	
; kx	4264500	4030339	234161	

foRrh; o"l 2010&2011

y[kk'kl'kd&2055 i fyl &800&vU; 0; ; &04&Qk; j l fo] 'kk[kk				
ekud en	foRrh; o"l 2010&11 ea i tr dy vuqlu	foRrh; o"l 2010&11 ea dy 0; ;	'kk @ l efi r /kujk'k	0; ; k/ld;
1	2	3	4	5
01 oru	26900000	26901512	-	1512
02 etnjh	39600	39520	80	
03 egakbz HRrk	9580000	9578093	1907	
04 ;k=k HRrk	235000	235000	0	
05 LFKu0 ;k=k HRrk	60500	60497	3	
06 vU; HRrs	2360000	2355306	4694	
08 dk; ky; 0; ;	35000	34896	104	
09 fo r 0; ;	106649	106640	9	
10 tydj @tyiHkj	65000	64977	23	
11 y[ku l kelxh	10000	9995	5	
13 VyhQku	29742	29725	17	
15 Mh0@i0 o vuj{k.k	830000	829968	32	
17 fdjk; k mi 'k'd	50000	50000	0	
27 fpdfRI k ifri r l	461358	460147	1211	
29 vuj{k.k	103125	102800	325	
42 vU; 0; ;	11000	10994	6	
47 dEl; Wj vuj{k.k	7000	6955	45	
; kx	40883974	40877025	8461	

foRrh; o"l 2010&2011

y[kk'kl'kd&2055 i fyl &109&fTyk i fyl &05&ifjogu 'kk[kk				
ekud en	foRrh; o"l 2010&11 ea i tr dy vuqlu	foRrh; o"l 2010&11 ea dy 0; ;	'kk @ l efi r /kujk'k	0; ; k/ld;
1	2	3	4	5
01 oru	19068763	19068763	0	
03 egakbz HRrk	5722553	5722553	0	
04 ;k=k HRrk	326000	325827	173	
05 LFKu0 ;k=k HRrk	15000	12695	2305	
06 vU; HRr:	2303558	2303558	0	
08 dk; ky; 0; ;	2000	2000	0	
15 Mh0@i0 o vuj{k.k	16500000	16499981	19	
27 fpdfRI k ifri r l	171696	171502	194	
42 vU; 0; ;	5000	4997	3	
	44114570	44111876	2694	

foRrh; o"K 2010&2011

y[kk'k'kd&2055 i fyl &109 ftyk i fyl &04 jkT; jSM; ks 'kk[kk				
ekud en	foRrh; o"K 2010&11 ea i klr dy vuŋku	foRrh; o"K 2010&11 ea dy 0; ;	'kK @ l efi r /kujk'k	0; ; k/ko;
1	2	3	4	5
01 oru	21269829	20673172	596657	
02 etnjh	4000	4000	0	
03 egakbz HRrk	7250000	7104946	145054	
04 ;k=k HRrk	200000	199921	79	
05 LFKukO ;k=k HRrk	6300	6130	170	
06 vU; HRrs	2625000	2616926	8074	
08 dk; ky; 0; ;	30000	29990	10	
09 fo r 0; ;	70333	70327	6	
11 y[ku l keloch	5000	4999	1	
13 VyhQku	10000	9816	184	
17 fdjk; k mi 'k'd	200	0	200	
25 y?k fuekZk	50000	49900	100	
26 e'ku l kt&l Ttk	70000	69992	8	
27 fpfdRI k i fri rZ	198380	198236	144	
29 vuj{k.k	30000	29942	58	
42 vU; 0; ;	56000	55997	3	
47 dEl; Wj vuj{k.k	10000	9950	50	
; kx	31885042	31134244	750798	

foRrh; o"K 2010&2011

y[kk'k'kd&2055 i fyl &101 vijf/kd vlošk.k&03 vfhkl puk bdkbz				
ekud en	foRrh; o"K 2010&11 ea i klr dy vuŋku	foRrh; o"K 2010&11 ea dy 0; ;	'kK @ l efi r /kujk'k	0; ; k/ko;
1	2	3	4	5
01 oru	22776000	22775243	757	
03 egakbz HRrk	7840000	7838332	1668	
04 ;k=k HRrk	336000	335992	8	
05 LFKukO ;k=k HRrk	50000	49780	220	
06 vU; HRrs	3645000	3644706	294	
08 dk; ky; 0; ;	22000	21992	8	
09 fo r 0; ;	25000	25000	0	
11 y[ku l keloch	11000	10948	52	
13 VyhQku	20000	19995	5	
27 fpfdRI k i fri r:	77500	77348	152	
42 vU; 0; ;	2000	1965	35	
47 dEl; Wj vuj{k.k	2000	1950	50	
; kx	34806500	34803251	3249	

foRrh; o"K 2010&2011

y[k' k' k' d & 2055 i fyl & 113 i fyl dfeZks dk dY; k.k&04 fpdfRI ky; &01 i fyl				
elud en	foRrh; o"K 2010&11 ea iRr dy vuqku	foRrh; o"K 2010&11 eady 0; ;	'k'k @ I efi r /kujk'k	0; ; k/kD;
1	2	3	4	5
01 oru	1330000	1328911	1089	
03 egakbz HRrk	455000	451183	3817	
06 vU; HRrs	90000	93149	0	-3149
08 dk; ky; 0; ;	7000	7000	0	
09 fo r 0; ;	10000	9958	42	
11 y[ku I kelxh	4000	4000	0	
27 fpdfRI k i fri rZ	97000	96944	56	
31I kelxh I Ei rZ	7000	6945	55	
39 v'k'k/h , oajl k; u	100000	99990	10	
42 vU; 0; ;	3000	3000	0	
; kx	2103000	2101080	1920	-3149

foRrh; o"K 2010&2011

y[k' k' k' d & 2055 i fyl 101 vijf/kd vlošk.k v[I rZrk 05 vijf/kd vlošk.k				
elud en	foRrh; o"K 2010&11 ea iRr dy vuqku	foRrh; o"K 2010&11 eady 0; ;	'k'k @ I efi r /kujk'k	0; ; k/kD;
1	2	3	4	5
01 oru	13700000	13237040	462960	
03 egakbz HRrk	4300000	4611039	0	&311039
04 ; k=k HRrk	300000	299982	18	
05 LFKuO ; k=k HRrk	76017	75970	47	
06 vU; HRrs	1870000	1872107	0	&2107
08 dk; ky; 0; ;	50000	49996	4	
09 fo r 0; ;	40000	39967	33	
11 y[ku I kelxh	25000	24973	27	
12 dk; ky; Qubj	50000	50000	0	
13 VyhQku	40000	39996	4	
15 MhO@iO o vuj{k.k	400000	399994	6	
17 fdjk; k mi 'k'd	22438	22438	0	
27 fpdfRI k i fri rZ	150000	149962	38	
42 vU; 0; ;	40000	39992	8	
45 vodk'k ; k=k 0; ;	40000	21656	18344	
47 dEI; Wj vuj{k.k	20000	19877	123	
; kx	21123455	20954989	481612	&313146

foRrh; o"l 2010&2011

y[k' k' d&2055 & i f y l & 101 & v i j k f / k d v l o s k . k & 04 & l j { k				
elud en	foRrh; o"l 2010&11 ea i l r d y v u p k u	foRrh; o"l 2010&11 e a d y 0; ;	' k s k @ l e f i r / k u j k ' k	0; ; k f / k d ;
1	2	3	4	5
01 oru	15005000	14976580	28420	
03 egakbz HRrk	5255000	5232500	22500	
04 ; k = k HRrk	180000	179505	495	
05 LFKukO ; k = k HRrk	15000	14870	130	
06 vU; HRrs	3291000	3286774	4226	
11 y[ku l kelxh	10000	10000	0	
15 MhO@iO o vuj{k.k	2600000	2599991	9	
27 f p f d R I k i f r i f r z	25000	24809	191	
42 vU; 0; ;	5000	4953	47	
; k s k	26386000	26329982	56018	

foRrh; o"l 2010&2011

y[k' k' d&2055 i f y l & 109 f t y k i f y l & 07 & ? M l o k j i f y l				
elud en	foRrh; o"l 2010&11 ea i l r d y v u p k u	foRrh; o"l 2010&11 e a d y 0; ;	' k s k @ l e f i r / k u j k ' k	0; ; k f / k d ;
1	2	3	4	5
01 oru	2800000	2759474	40526	
02 etnijh	5000	5000	0	
03 egakbz HRrk	1040000	1009943	30057	
04 ; k = k HRrk	20000	19655	345	
05 LFKukO ; k = k HRrk	30000	30000	0	
06 vU; HRrs	290000	256595	33405	
08 dk; ky; 0; ;	1100000	1099992	8	
09 fo r 0; ;	40000	39990	10	
10 tyd j @ t y i k k j	2000	1898	102	
11 y[ku l kelxh	6000	5992	8	
13 V y h Q k u	15000	14813	187	
27 f p f d R I k i f r i f r z	100000	99783	217	
42 vU; 0; ;	15000	14980	20	
; k s k	5463000	5358115	104885	

foRrh; o"K 2010&2011

y[kk'k'kd &2055 i fyl &110 xte i fyl &03 xte i fyl ed;				
elud en	foRrh; o"K 2010&11 ea i Rr dy vuqku	foRrh; o"K 2010&11 eady 0; ;	'kK @ I efi R /kujk'k	0; ; k/ko;
1	2	3	4	5
01 oru	1640000	1639800	200	
42 vU; 0; ;	10000	10000	0	
; kx	1650000	1649800	200	

foRrh; o"K 2010&2011

y[kk'k'kd &2055&i fyl &00&800&vU; 0; ; &10 d fHk eyk 0; oLFk				
elud en	foRrh; o"K 2010&11 ea i Rr dy vuqku	foRrh; o"K 2010&11 eady 0; ;	'kK @ I efi R /kujk'k	0; ; k/ko;
1	2	3	4	5
04 ; k=k HRRk	7500000	7499935	65	
; kx	7500000	7499935	65	

foRrh; o"K 2010&2011

y[kk'k'kd &2055 i fyl &113 i fyl dfeZks dk dY; k.k&09 dY; k.k fuf/k				
elud en	foRrh; o"K 2010&11 ea i Rr dy vuqku	foRrh; o"K 2010&11 eady 0; ;	'kK @ I efi R /kujk'k	0; ; k/ko;
1	2	3	4	5
42 vU; 0; ;	280170	280154	16	
; kx	280170	280154	16	

foRrh; o"K 2010&2011

y[kk'k'kd 2055&i fyl &113 i fyl dfeZ ks dk dY; k.k&05 [ky dm I ekjky				
elud en	foRrh; o"K 2010&11 ea i Rr dy vuqku	foRrh; o"K 2010&11 eady 0; ;	'kK @ I efi R /kujk'k	0; ; k/ko;
1	2	3	4	5
42 vU; 0; ;	1400000	1399997	3	
; kx	1400000	1399997	3	

foRrh; o"K 2010&2011

y[kk'kk'kd 2055 & i fyl & 109 & ftyk i fyl & 08 & ; krk; kr i fyl				
elud en	foRrh; o"K 2010&11 ea i tr dy vuoku	foRrh; o"K 2010&11 eady 0; ;	'kk @ l efi r /kujk'k	0; ; k/kD;
1	2	3	4	5
08 dk; ky; 0; ;	20000	19990	10	
11 y[ku l kelxh	10000	9997	3	
42 dY; k.k fuf/k	100000	99996	4	
; kx	130000	129983	17	

foRrh; o"K 2010&2011

y[kk'kk'kd 2055 & i fyl & 109 & ftyk i fyl & 11 & 'oku nya				
elud en	foRrh; o"K 2010&11 ea i tr dy vuoku	foRrh; o"K 2010&11 eady 0; ;	'kk @ l efi r /kujk'k	0; ; k/kD;
1	2	3	4	5
08 dk; ky; 0; ;	50000	49993	7	
25 y?k fuekz k	50000	49800	200	
25 y?k fuekz k	17000	16935	65	
; kx	117000	116728	272	

fclnq I 4; k & 12

vuqku jkt l gk; rk dk; Zdeka ds fdz kll; u dh jhfr ftl ea vkoflVr jkf" k vls , d s dk; Zdeka ds ykHkFkZ ka dk C; kjk l fEefyr gS%&

ifyl foHkx dks vkoflVr ctV ds vfrfjDr jkt l gk; rk ds vlzkr dkbZ /kujkf" k Lohdfr ugha gPz gA

fclnq I 4; k & 13

fj; k; rka vuqk i =ka rFk i kf/kdkfj; ka ds i klrdrkZ/ka ds l Ecu/k ea fof" k'V; ka %&

"kkl u }kjk fu/kkfjr uhr , oa ifdz k ds vuq kj vuqkyu fd; k tkrk gA

fclnq I 4; k & 14

fdl h byDVkfud : i ea mi yC/k l puk ds l Ecu/k C; kS} tks muds mi yC/k gla ; k muds }kjk /kkfjr gla %&

1& ftyk Lrj ij vij/kka ds vkadMs , oa vl; egroi wkZ l puk; a byDVkfud : i ea mi yC/k jgrh gA

2& vf/kdkfj; ka@depkfj; ka dks Hkqrku fd; s tk jgs oru , oa HkRka dh l puk dks kxkj ds dEl; Wj ea jgrh gA

fclnq I 4; k & 15

l puk vfhki klr djus ds fy, ukxfjdks dks mi yC/k l fo/kkvka dk fooj.k fdl h i qrdky; ; k okpu d{k dh ; fn ykd mi ; sx ds fy; s0; oLFk dh x; h gks rks ml dk HkH fooj.k %&

ifyl dk; ky; Lrj ij i qrdky; mi yC/k gS ftl ea mi yC/k i qrdka dk mi ; sx ifyl foHkx ds vf/kdkfj; ka@depkfj; ka }kjk fd; k tkrk gA

fclnq l 4; k & 16

vi hyh; vf/kdkjh@ykd l puk vf/kdkjh@l gk; d ykd l puk vf/kdkfj; ka ds uke] i nuke vls vl; fof" k' V; ka %&

dz 01 0	ykd i kf/kdkjh dk; kzy; dk iwz uke , oa irk nijHkk" k l fgr	ukfer ykd l puk vf/kdkjh dk iwz uke , oa irk nijHkk" k l fgr	Ukfer i Eke vi hyh; vf/kdkjh dk iwz uke , oa irk nijHkk" k l fgr
1	Jh th0l h0 /; kuh i fyl v/kh{k d ½ xkeh. k½ dk; kzy; ofj" B i fyl v/kh{k d ngjknw 9411112775	&	Jh l at; xā; ky i fyl mi egkfujh{k d] x<oky ifj {k=} ngjknw 9411112945
2		Jh fnus" k plnz ckfB; ky ¼fujh{k d½ Fkkuk dkrökyh 9411112809	Jh i ænz Mksky {k=k0 dkrökyh 9411112759
3		Jh fnus" k Hk. Mkjh ¼fujh{k d½ Fkkuk Mkyuokyk 9411112814	Jherh " ork pkcs {k=k0 Mkyuokyk 9411112993
4		Jh v0oy fl g jkor ¼fujh{k d Fkkuk dSV 9411112810	Jh i ænz Mksky {k=k0 dkrökyh 9411112759
5		Jh inhi dæj jk. kk ¼Fkkuk/; {k½ Fkkuk dyeUvkmu 9411112812	Jh yfyr eksu mi rñh {k=k0 ug; dkykuh
6		Jh , l 0, l 0 fo" V ¼fujh{k d½ Fkkuk i Vsyuxj 9411112825	Jh uouhr Hktyj {k=k0 i Vsyuxj 9411111959
7		Jh vjfoln fl g jkor ¼i Hkkjh fujh{k d½ Fkkuk cl Urfogkj 9411112824	Jh uouhr Hktyj {k=k0 i Vsyuxj 9411111959

8		Jh jfo dękj ¼Fkkuk/; {k½ Fkkuk jk; ij 9411112823	Jherh " ork pkšs {ks=k0 Mkyuokyk 9411112993
9		Jh v" ksd dękj R; kxh ¼Fkkuk/; {k½ Fkkuk jkt ij 9411112811	Jh enu fā g Ql ğk.k {ks=k0 el ijh 9411112751
10		Jh ijhf{kr dękj ¼ujh{kd½ Fkkuk el ijh 9411112817	Jh enu fā g Ql ğk.k {ks=k0 el ijh 9411112751
11		Jh vkj0ih0 I rh ¼Fkkuk/; {k½ Fkkuk th0vkj0ih0 9411112921	Jh iębnz Mkšky {ks=k0 dkrökyh 9411112759
12		Jh vej thr fā g ¼Fkkuk/; {k½ Fkkuk usg: dkykuh 9411112991	Jh yfyr ekgu mirh {ks=k0 usg: dkykuh
13		Jh xtbnz fl g jkšsyk ¼ujh{kd½ Fkkuk Mkbğkyk 9411112818	Jherh I fjrk Mkšky {ks=k0 I nj 9411112089
14		Jh jktho jkškk.k ¼Fkkuk/; {k½ Fkkuk jkuhi kškjh 9411112826	Jh Vh0Mh0csyk {ks=k0 _f" kds k 9411112752
15		Jh jkts" k "kkg ¼Fkkuk/; {k½ Fkkuk jk; okyk 9411112822	Jh Vh0Mh0csyk {ks=k0 _f'kds" k 9411112752
16		Jh jfolnz dękj pekyh ¼ujh{kd½ Fkkuk _f'kds" k 9411112815	Jh Vh0Mh0csyk {ks=k0 _f'kds" k 9411112752
17		Jh I w Bkw k.k fl g usch ¼Fkkuk/; {k½ Fkkuk I gl ij 9411112816	Jherh I fjrk Mkšky {ks=k0 I nj 9411112089

18		Jh /khjbnz fl g jkor ¼fujh{k d½ Fkkuk fodkl uxj 9411112819	Jh fxjh" k PKUnz fctYok.k {k=k0 fodkl uxj 9411112745
19		Jh iadt iklfj; ky ¼Fkkuk/; {k½ Fkkuk dkyI h 9411112820	Jh fxjh" k PKUnz fctYok.k {k=k0 fodkl uxj 9411112745
20		Jh eukst jkor ¼Fkkuk/; {k½ Fkkuk pdjkrk 9411112813	Jh fxjh" k PKUnz fctYok.k {k=k0 fodkl uxj
21		Jh gjh" k fxjh ¼ Q0, I 0vk½ Qk; j I foI ngjknw 8126261974	Jh plnu fl g thuk & eI; vfxu "keu vf/k0
22		Jh nkuhje ¼ Q0, I 0vk½ Qk; j I foI _f'kds" k 9411463702	Jh plnu fl g thuk & eI; vfxu "keu vf/k0
23		Jh plnekgu XokMh ¼ Q0, I 0vk½ Qk; j I foI fodkl uxj 9412506952	Jh plnu fl g thuk & eI; vfxu "keu vf/k0
24		, yOMh0 feJk ¼ I 0, I 0vk½ Qk; j I foI I sykdpZ	Jh plnu fl g thuk & eI; vfxu "keu vf/k0
25		Jh blnzthr vk; ; ¼ I 0, I 0vk½ Qk; j I foI el yjh 9897130933	Jh plnu fl g thuk & eI; vfxu" keu vf/k0

fclnq l ; k & 17

, d h vU; I p u k t k s f o f g r d h t k ; % &

I p u k e k a x u s o k y s 0 ; f D r } k j k ; g H k h L i ' V f d ; k t k u k p k f g , f d o g I p u k f d l h i z k s t u f d f y , p k g r k g s r F k k m l I p u k d k m l l s D ; k l E c l u / k g a ; f n m l d s } k j k e k a h x ; h I p u k l s f o l k k x @ j k T ; v F k o k j k ' V a d h l g { k k v F k o k v f g r u g l o r k g k s r k s m l s I p u k m i y C / k d j k n h t k ; a

I p u k d k v f / k d k j f o / k s d] 2005 d s i f j i s k e a i f y l d k ; Z d r k y r k v k s x q k o R r k e a J s B r k y k u s d s l E c l u / k e a t u i n d s l e l r i f y l v f / k d k f j ; k a d k s r R d k y d k ; b k g h d j u s d s f u n s k f n ; s x ; s g a ; g f o / k s d v k e t u r k d h c f u ; k n h v f / k d k j k a l s t i / k g a v r % l e l r v f / k d k f j ; k a d k s " k k l u @ i f y l e q ; k y ; L r j l s i k l r ; k s t u k v k a v k s d k ; k a d h i j h t k u d k j h L o B N k i m d I p u k ; a t u r k d k s e g s k d j k u s d s f u n s k f n ; s x ; s g a r F k k / k k j k & 4 1 / 4 1 1 / 4 4 1 / 2 1 / 2] 4 1 / 8 1 / 2 , o a 4 1 / 4 1 / 2 d s v l r x r 17 f c l n q / k a i j I p u k i f y l d k ; k y ; d s I p u k i z d k s B @ l f o / k k d { k e a m i y C / k g a I p u k v k a d h m i y C / k r k d s f y ; s c o l k b V r F k k v U ; i z k j d s v f l k y s [k k a d k s v / ; k o f / k d j [k k x ; k g a